

PRODUCT DESCRIPTION

- Minimum dimensions for LED strips 10 mm wide
- Easy mounting
- Low weight

Fill empty fields

Product nr.	
Fixture type	
Company	
Job name	
Date	

**TECHNICAL SPECIFICATION**

B5390NA_1	Non anodized (raw)	1000 mm
B5390NA_2	Non anodized (raw)	2000 mm
B5390ANODA_1	Silver anodized	1000 mm
B5390ANODA_2	Silver anodized	2000 mm

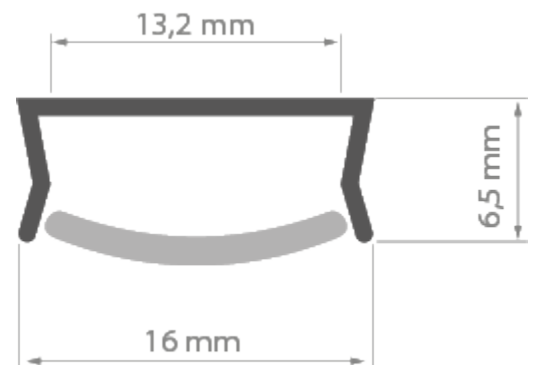
**RELATED PRODUCTS**

COVERS

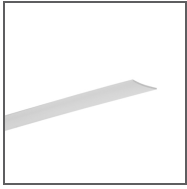

Ref: 17004

END CAPS

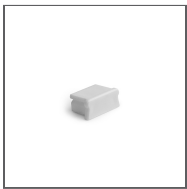

Ref: 20051

ACCESSORIES



Ref: 00644



Ref: 42216

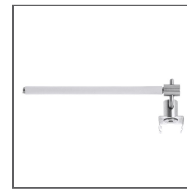

Ref: 42051



Ref: 42217

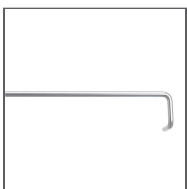

Ref: 42116



Ref: 24190

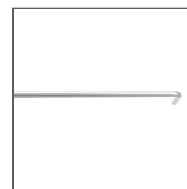

Ref: 42115



Ref: 00647



Ref: 42218

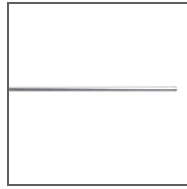

Ref: 42102

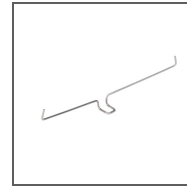

Ref: 00800V1



Ref: 00645

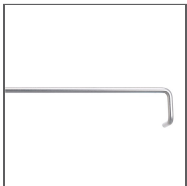

Ref: 42114



Ref: 00649

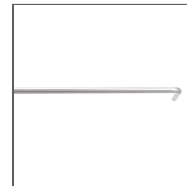

Ref: 42113



Ref: 42214

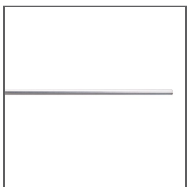

Ref: 42101



Ref: 42215



Ref: 42213

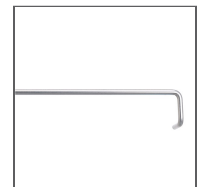

Ref: 42200



Ref: 00646

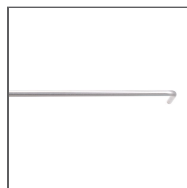

Ref: 42201



Ref: 00651

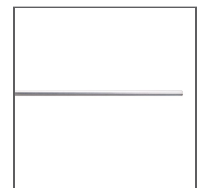

Ref: 42202



Ref: 42209

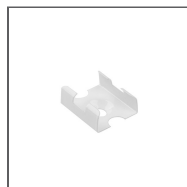

Ref: 24223

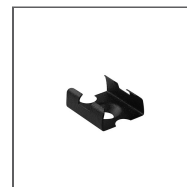

Ref: 24189

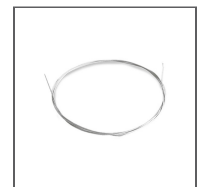

Ref: 1397



Ref: 42501

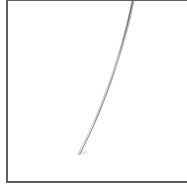

Ref: 1528