

PRODUCT DESCRIPTION

- Will accommodate LEDs up to 14.6 mm wide
- Possible to obtain a watertight lighting fixture

Fill empty fields

Product nr.	
Fixture type	
Company	
Job name	
Date	

**TECHNICAL SPECIFICATION**

B9325ANODA_1	Silver anodized	1000 mm
B9325ANODA_2	Silver anodized	2000 mm
B9325ANODA_3	Silver anodized	3000 mm

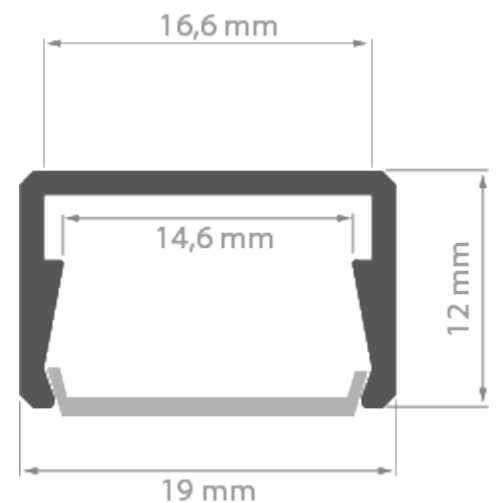
**RELATED PRODUCTS**

COVERS

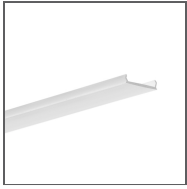

Ref: 17039

END CAPS



Ref: 24236

ACCESSORIES



Ref: 00644



Ref: 42211

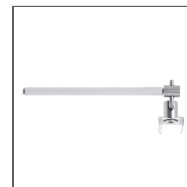

Ref: 42051

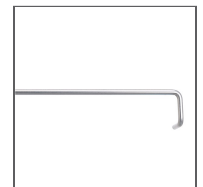

Ref: 42116



Ref: 24144



Ref: 42212

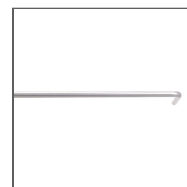

Ref: 42115

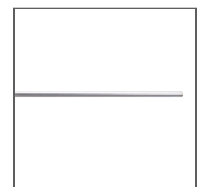

Ref: 42102

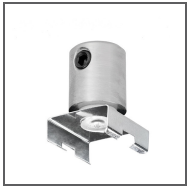

Ref: 00652

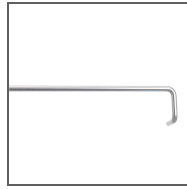

Ref: 42114

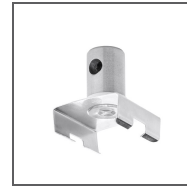

Ref: 42210

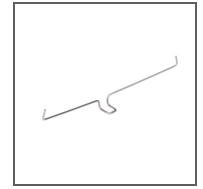

Ref: 00800V1

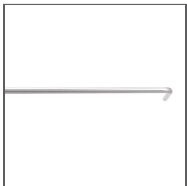

Ref: 42113



Ref: 42214



Ref: 00649



Ref: 42215



Ref: 00653

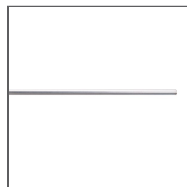

Ref: 42101

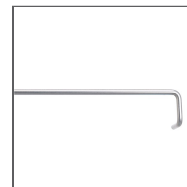

Ref: 42200



Ref: 42213

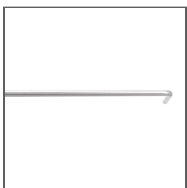

Ref: 42201

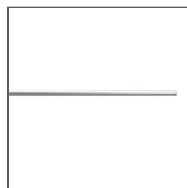

Ref: 42202



Ref: 00651



Ref: 42209

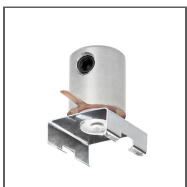

Ref: 00654



Ref: 1399

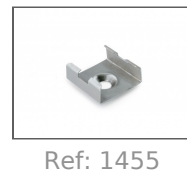

Ref: 1455



Ref: 42258



Ref: 1397



Ref: 42252

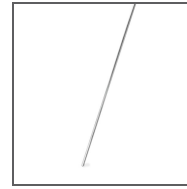

Ref: 42501

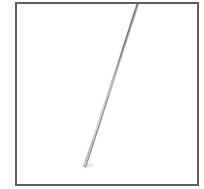

Ref: 42518

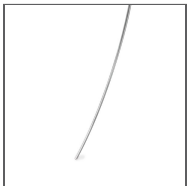

Ref: 1528

MARKETING MATERIALS



Ref: 90120M

COUPLERS - connection methods for profiles



L135

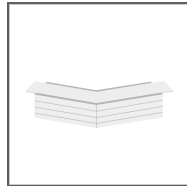

L135PW

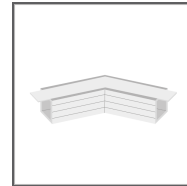

L135PZ

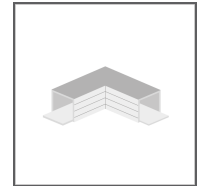

L90



L90PW

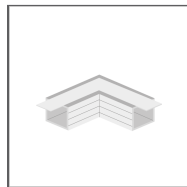

L90PZ

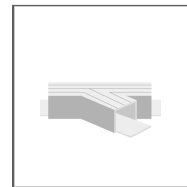

T135L



T135R

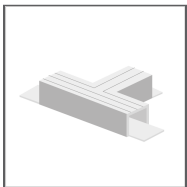

T90

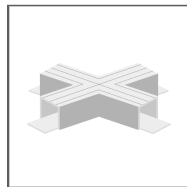

X135

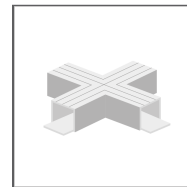

X90