

PRODUCT DESCRIPTION

- Easy LED service (assembly and disassembly OPK-4 extrusion „on click”)
- Line of light in the built-in lighting fixture without visible aluminum elements
- Can build fixtures going seamlessly from built-in to suspended ones
- OPK-4 profile can be bent
- Smoothly changing lighting height
- Fits in the thickness of a drywall board (12mm)
- Lighting fixtures can be combined to form lighting strings (ZM connectors)
- The standard TPK-4 profile comes with a “foam technical cover” that facilitates “clean” mounting of the fixture in the drywall



Fill empty fields

Product nr.	
Fixture type	
Company	
Job name	
Date	

TECHNICAL SPECIFICATION

C0370ANODA_2	Silver anodized	2000 mm
C0370ANODA_3	Silver anodized	3000 mm

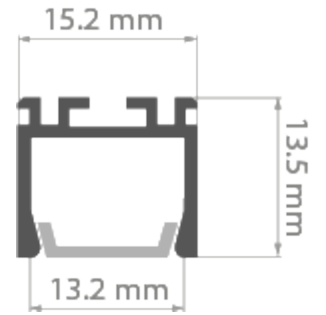

RELATED PROFILES

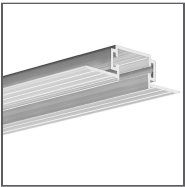

Ref: 18044NA

RELATED PRODUCTS

COVERS



Ref: 17036

60°

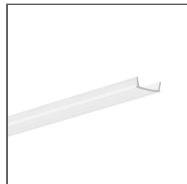

Ref: 17035

90°

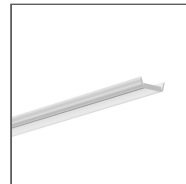

Ref: 1370

50°

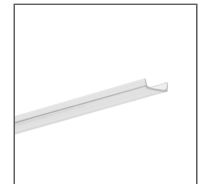

Ref: 17122

70°





Ref: 1369

100°

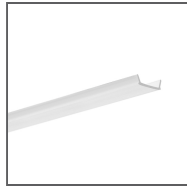

Ref: 17121

100°

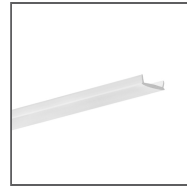

Ref: 17037

110°



Ref: 17076

120°

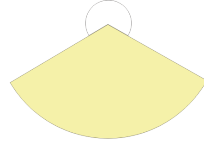

END CAPS



Ref: 24238

ACCESSORIES



Ref: 42717

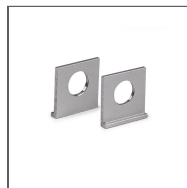

Ref: 42512

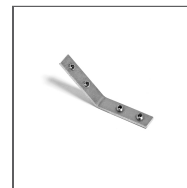

Ref: 42719

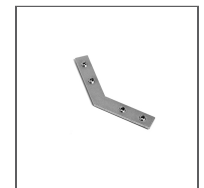

Ref: 42720



Ref: 42718

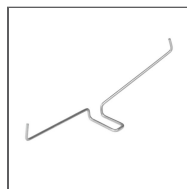

Ref: 00293V1

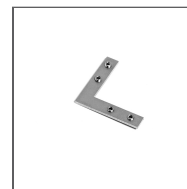

Ref: 42716

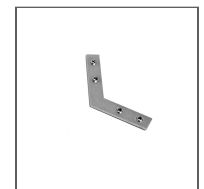

Ref: 42728

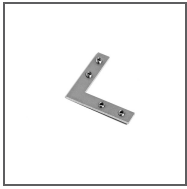

Ref: 42723

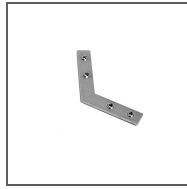

Ref: 42729

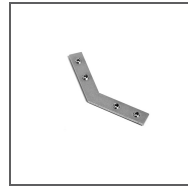

Ref: 42725

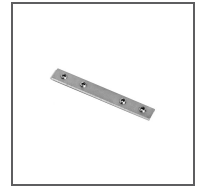

Ref: 42724



Ref: 42726

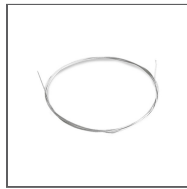

Ref: 1397



Ref: 42256



Ref: 42250

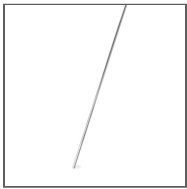

Ref: 42501

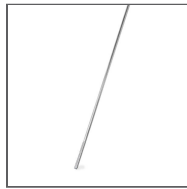

Ref: 42518

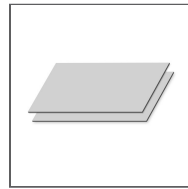

Ref: 70261