

PRODUCT DESCRIPTION

- Possible obtaining a circular cross-section of the lighting fixture (together with the LUK cover)
- Smooth walls ensure modern aesthetics
- Possible systemic suspension of the profile (KLUŚ accessories).



Fill empty fields

Product nr.	
Fixture type	
Company	
Job name	
Date	

TECHNICAL SPECIFICATION

B8505ANODA_1	Silver anodized	1000 mm
B8505ANODA_2	Silver anodized	2000 mm
B8505ANODA_3	Silver anodized	3000 mm

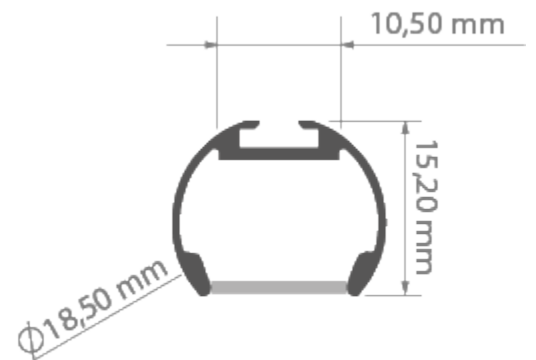

RELATED PRODUCTS

COVERS



Ref: 17036

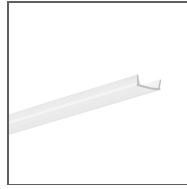

Ref: 17035

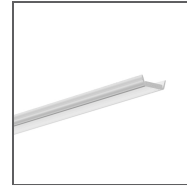

Ref: 1370

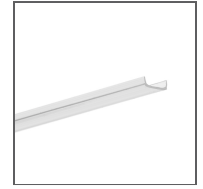

Ref: 17122



Ref: 1369

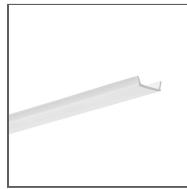

Ref: 17121

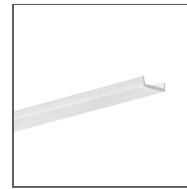

Ref: 17037

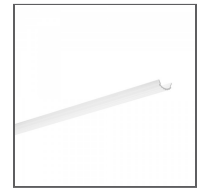

Ref: 17076

END CAPS



Ref: 42620



Ref: 24212

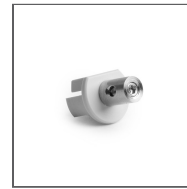

Ref: 42619



Ref: 24203



Ref: 24204

ACCESSORIES



Ref: 42717

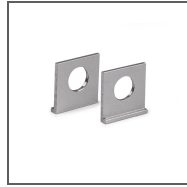

Ref: 42512



Ref: 00648

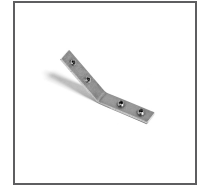

Ref: 42719



Ref: 42720

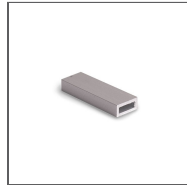

Ref: 00036

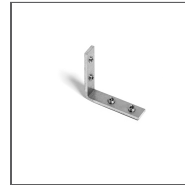

Ref: 42718

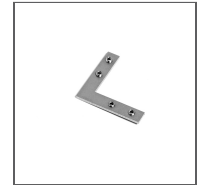

Ref: 42716



Ref: 00035

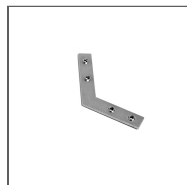

Ref: 42728

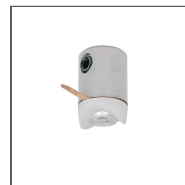

Ref: 00655

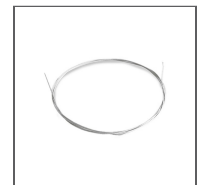

Ref: 1397



Ref: 42256



Ref: 42250

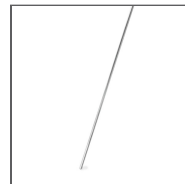

Ref: 42501

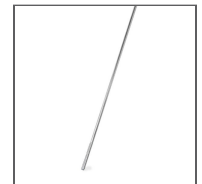

Ref: 42518

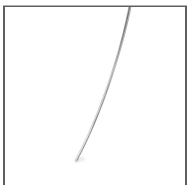

Ref: 1528

MARKETING MATERIALS



Ref: 90106M

COUPLERS - connection methods for profiles



L135

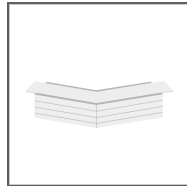

L135PW

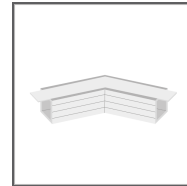

L135PZ

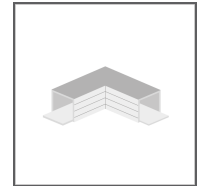

L90

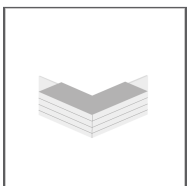

L90PW

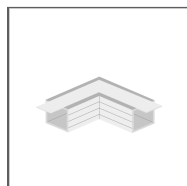

L90PZ

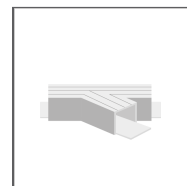

T135L

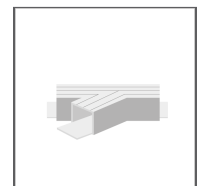

T135R

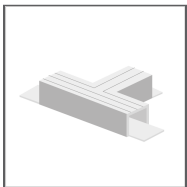

T90

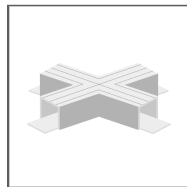

X135

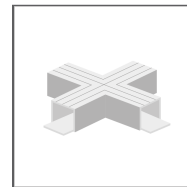

X90