

**PRODUCT DESCRIPTION**

- Clean design of the lighting fixture
- Easy snap-in assembly and disassembly
- Small size

Fill empty fields

Product nr.	
Fixture type	
Company	
Job name	
Date	

**TECHNICAL SPECIFICATION**

C0599ANODA_1	Silver anodized	1000 mm
C0599ANODA_2	Silver anodized	2000 mm
C0599ANODA_3	Silver anodized	3000 mm

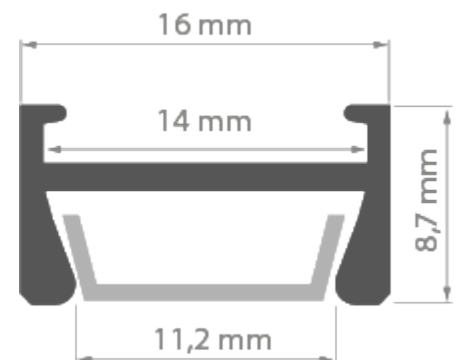
**RELATED PRODUCTS****COVERS**



Ref: 17036

**110°**



Ref: 17035

**110°**

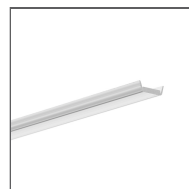

Ref: 1370

**110°**

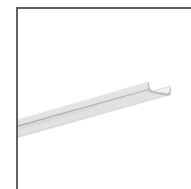

Ref: 17122

**120°**

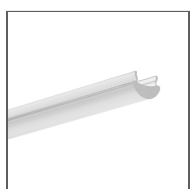
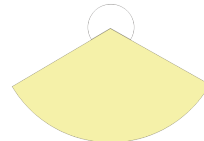

Ref: 00220

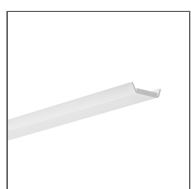

Ref: 1369

**110°**

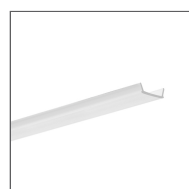

Ref: 17121

**110°**

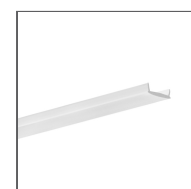

Ref: 17037

**110°**

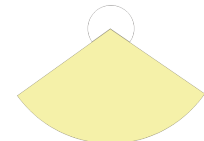

## END CAPS



Ref: 24261

## ACCESSORIES



Ref: 24214

## MARKETING MATERIALS



Ref: 90121M