

**PRODUCT DESCRIPTION**

- No interference with the structure of drywall ceilings and walls
- Ability to create a line of light
- Can be combined in straight and broken linear runs
- Easy mounting
- Masking the uneven edges of grooves

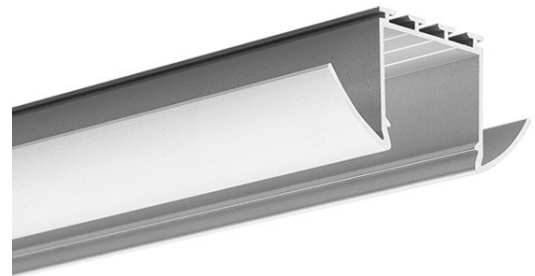

Fill empty fields

|              |  |
|--------------|--|
| Product nr.  |  |
| Fixture type |  |
| Company      |  |
| Job name     |  |
| Date         |  |

**TECHNICAL SPECIFICATION**

|              |                 |         |
|--------------|-----------------|---------|
| B5551ANODA_1 | Silver anodized | 1000 mm |
| B5551ANODA_2 | Silver anodized | 2000 mm |
| B5551ANODA_3 | Silver anodized | 3000 mm |

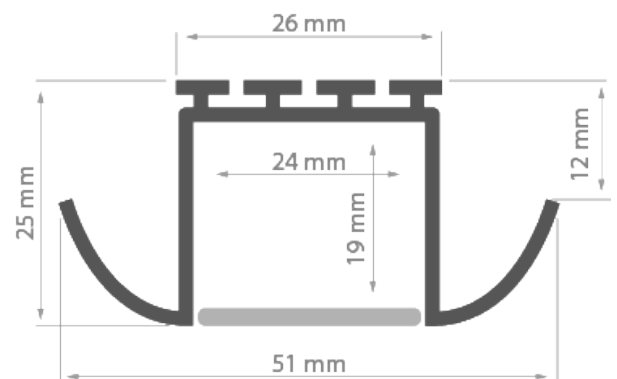

**RELATED PRODUCTS**

COVERS

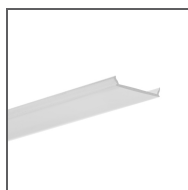

Ref: 17042

60°

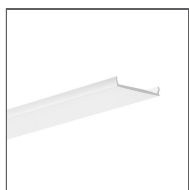

Ref: 17032V1

110°

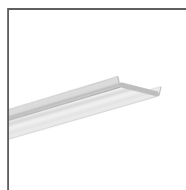

Ref: 17022

70°

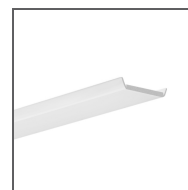
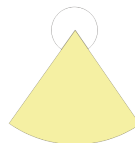

Ref: 17011

100°



END CAPS



Ref: 24200



Ref: 24008

ACCESSORIES

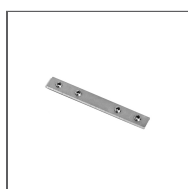

Ref: 42717



Ref: 00838V1

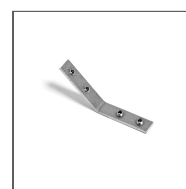

Ref: 42719

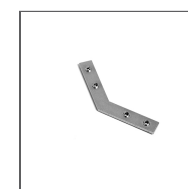

Ref: 42720



Ref: 42718

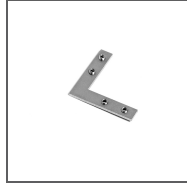

Ref: 42716

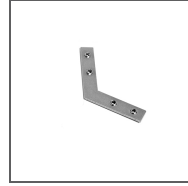

Ref: 42728

## MARKETING MATERIALS



Ref: 90052

**COUPLERS** - connection methods for profiles



L135

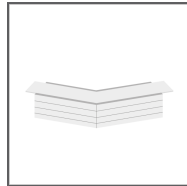

L135PW

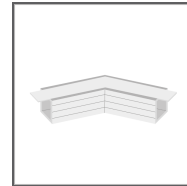

L135PZ

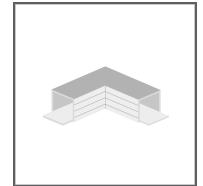

L90

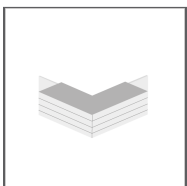

L90PW

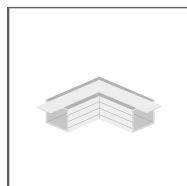

L90PZ

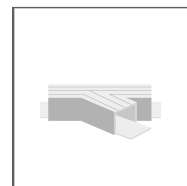

T135L

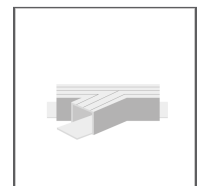

T135R

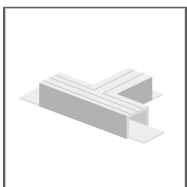

T90

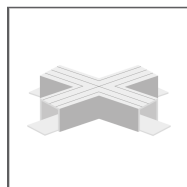

X135

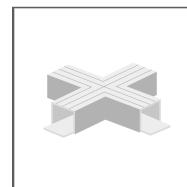

X90