

PRODUCT DESCRIPTION

- Multiple mounting methods
- Three types of dedicated covers
- Can be connected into linear straight or broken runs
Ability to create a line of light

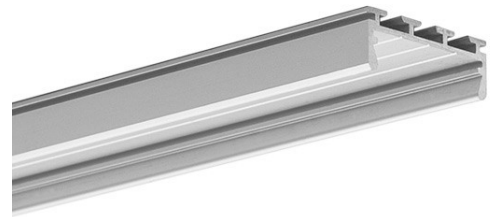

Fill empty fields

Product nr.	
Fixture type	
Company	
Job name	
Date	

TECHNICAL SPECIFICATION

B5556ANODA_1	Silver anodized	1000 mm
B5556ANODA_2	Silver anodized	2000 mm
B5556ANODA_3	Silver anodized	3000 mm

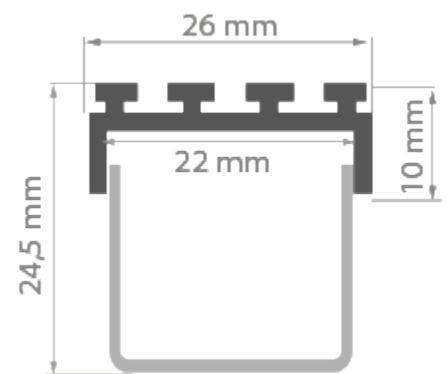
**RELATED PROFILES**

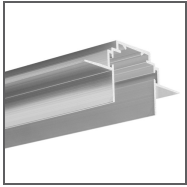

Ref: C0399NA

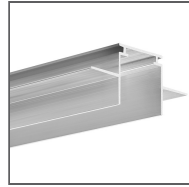

Ref: B5555V1NA

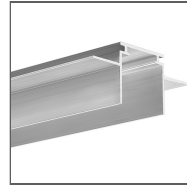

Ref: B6638V1NA

RELATED PRODUCTS

COVERS

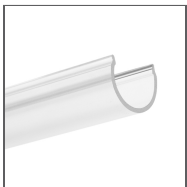

Ref: 17006

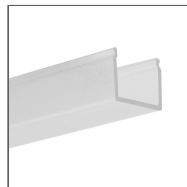

Ref: 00415

120°

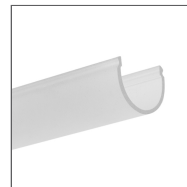

Ref: 17008

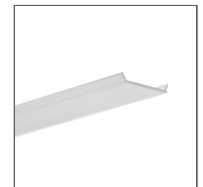

Ref: 17042

100°



Ref: 17032V1

110°

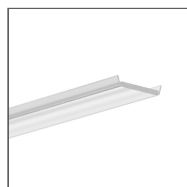

Ref: 17022

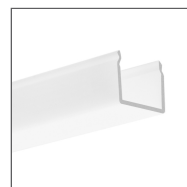

Ref: 17007

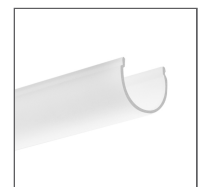

Ref: 00413



Ref: 17011

100°



END CAPS



Ref: 24035



Ref: 24036



Ref: 24007



Ref: 24029



Ref: 24030



Ref: 24131

ACCESSORIES



Ref: 42512



Ref: 42051

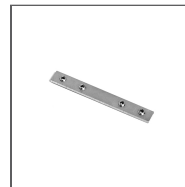

Ref: 42717



Ref: 00644

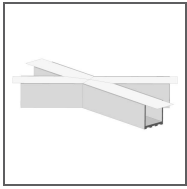

Ref: 42750

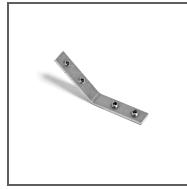

Ref: 42719

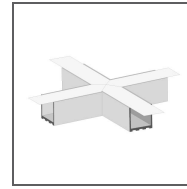

Ref: 42749

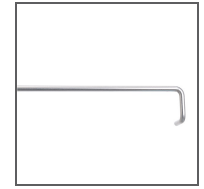

Ref: 42116



Ref: 42748

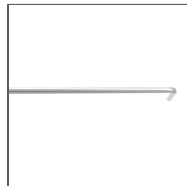

Ref: 42115

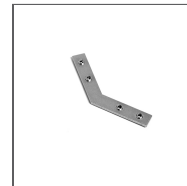

Ref: 42720

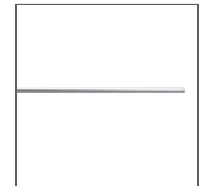

Ref: 42102



Ref: 42718

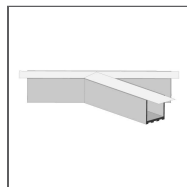

Ref: 42746

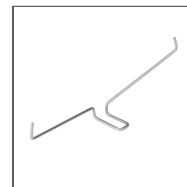

Ref: 00293V1

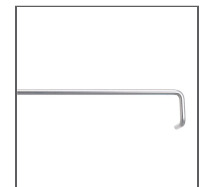

Ref: 42114

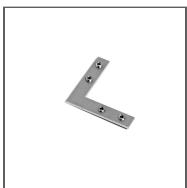

Ref: 42716

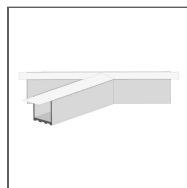

Ref: 42747



Ref: 24143

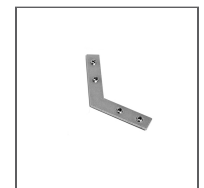

Ref: 42728



Ref: 42214

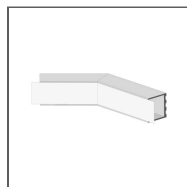

Ref: 42744



Ref: 00649

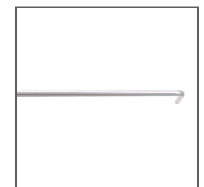

Ref: 42113

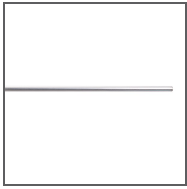

Ref: 42101



Ref: 42215

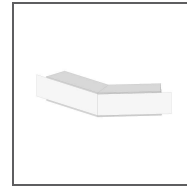

Ref: 42743

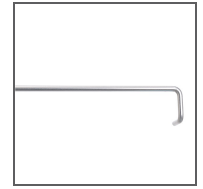

Ref: 42200



Ref: 42213

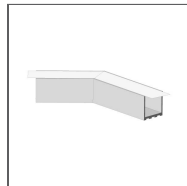

Ref: 42745

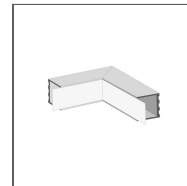

Ref: 42742

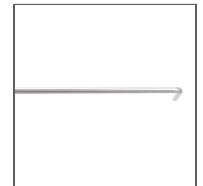

Ref: 42201



Ref: 00651

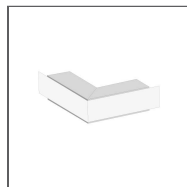

Ref: 42741



Ref: 24271

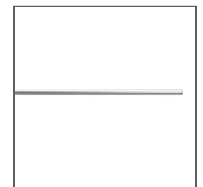

Ref: 42202



Ref: 42209

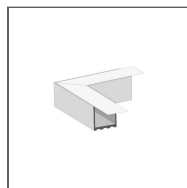

Ref: 42740

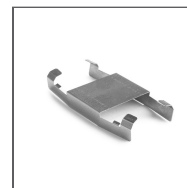

Ref: 24235

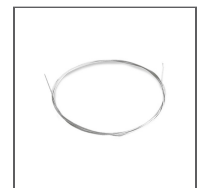

Ref: 1397

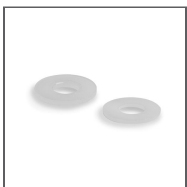

Ref: 42203



Ref: 42256

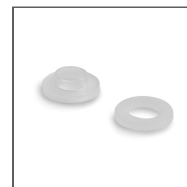

Ref: 42204



Ref: 24003



Ref: 42205

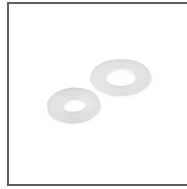

Ref: 42712



Ref: 42250

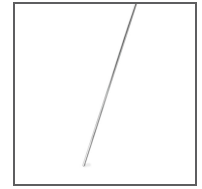

Ref: 42501



Ref: 42518

MARKETING MATERIALS



Ref: 90080M



Ref: 90120M



Ref: 90097



Ref: 90113M



Ref: 90052

COUPLERS - connection methods for profiles



L135

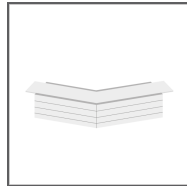

L135PW

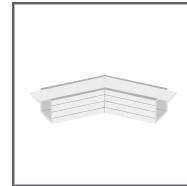

L135PZ

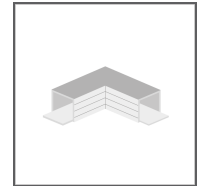

L90



L90PW

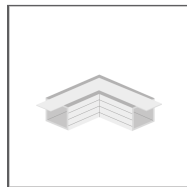

L90PZ

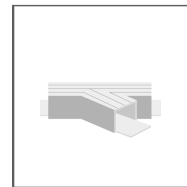

T135L



T135R

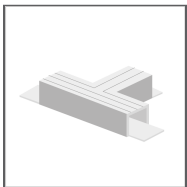

T90

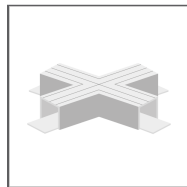

X135

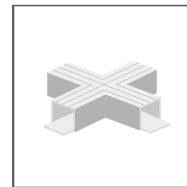

X90