

PRODUCT DESCRIPTION

- Combines several functions:
 - lighting fixture
 - frame for a stretched ceiling
 - frame for a suspended ceiling made of plasterboard, etc.
- The extrusion has a channel adapted to attach standard harpoons used in stretched surfaces.
- The FOLED system opens new possibilities of interior design

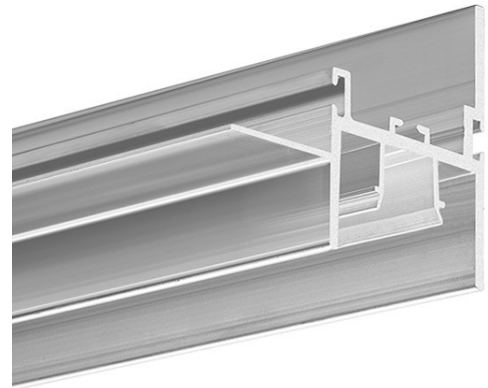

Fill empty fields

Product nr.	
Fixture type	
Company	
Job name	
Date	

TECHNICAL SPECIFICATION

B8334V1NA_1	Non anodized (raw)	1000 mm
B8334V1NA_2	Non anodized (raw)	2000 mm
B8334V1NA_3	Non anodized (raw)	3000 mm

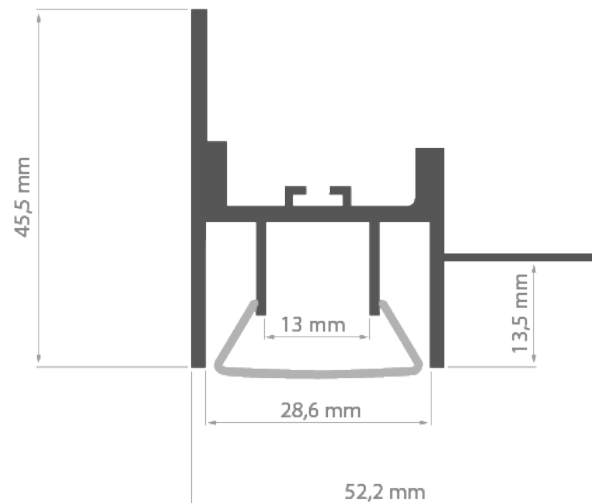

RELATED PROFILES

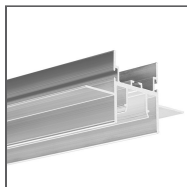

Ref: B8332V1NA

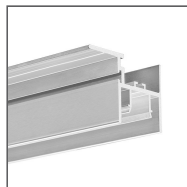

Ref: B8333V1NA

RELATED PRODUCTS

COVERS

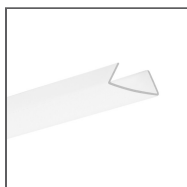

Ref: 17077V1

ACCESSORIES

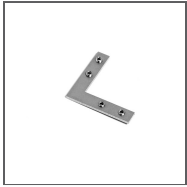

Ref: 42723

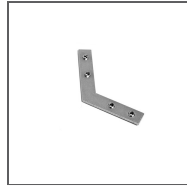

Ref: 42729

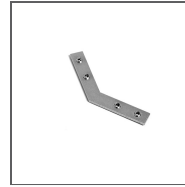

Ref: 42725

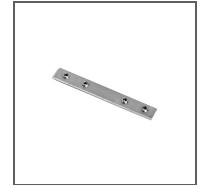

Ref: 42724



Ref: 42727

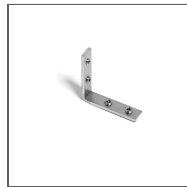

Ref: 42726

MARKETING MATERIALS



Ref: 90111M