

PRODUCT DESCRIPTION

The information contained in the description applies to the PIKO-ZM system (a set of PIKO-ZM and TEPIKO profiles)

- Ability to build fixtures going seamlessly from recessed to suspended
- Very small size (only 10 mm wide)
- The PIKO-ZM lighting fixture is bendable
- Easy LED servicability
- Fits in the thickness of a drywall board (12mm)
- Ability to build light strings (with ZM connectors)
- TEPIKO features a "TEPIKO protective insert", which facilitates clean mounting of the fixture in drywall



FINISH :

Silver anodized

*Custom colors available upon request

Fill empty fields

Product nr.	
Fixture type	
Company	
Job name	
Date	

TECHNICAL SPECIFICATION

Application

- for construction of serviceable LED lighting fixtures, straight and angled, built-in and suspended, producing the effect of a "thin line of light"

Assembly

- TEPIKO is mounted in drywall boards using elastic fixing glues
- the "built-in" PIKO-ZM is mounted in the TEPIKO profile with the **TEKNIK** latch (sold separately)
- the "suspended" PIKO-ZM is mounted using other KLUŚ accessories dedicated to the "small lock"

Additional information

- fast and reliable installation of sealed LED strips "5-KLIK" (LED strip in a special silicone sleeve ensuring increased tightness)
- Ideal for use in bathrooms and other rooms with high humidity
- recommendation:

Profile length	1 m	2 m	3 m
Number of TEKNIK latches	4	9	14

- the TEPIKO profile is sold with the "TEPIKO protective insert"
- spece for LED strip: 7.2 mm

Profile bending

- the profile can be twisted along the axis

Minimum internal radius	Minimum external radius
220 mm	120 mm

- minimum radius- bending radius which when exceeded causes destruction (deformation, bending or lack of compatibility with other accessories, e.g. covers, end caps, etc.) of the profile
- internal radius- refers to the profile bent so that the cover is facing the inside of the arch
- external radius- refers to the profile bent so that the cover is facing the outside of the arch
- irregular curves are possible after consultation and individual quotation
- when bending anodized profiles, one should be aware of cracking of the anode coating (which may be more or less visible depending on the radius)

AVAILABLE LENGTHS

Ref. nr.	surface finish	available lengths
C1168ANODA_1	Silver anodized	1000 mm
C1168ANODA_2	Silver anodized	2000 mm
C1168ANODA_3	Silver anodized	3000 mm

TECHNICAL DRAWING

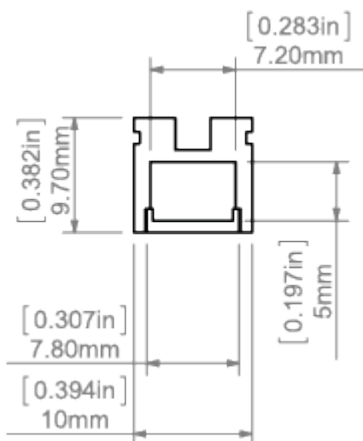

RELATED PROFILES



TEPIKO Profile
Ref: 18046

RELATED PRODUCTS

COVERS

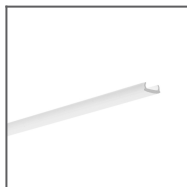

PIKO frosted
Cover
Ref: 17034

END CAPS



PIKO-ZM grey End
cap
Ref: 24307

ACCESSORIES



FI-10-ZM-P
Fastener
Ref: 42244



FI-10-ZM-W
Fastener
Ref: 42242



Gland
Ref: 42264



PUSZ-LIN-ZM
Fastener
Ref: 42256



PUSZ-PRET-ZM
Fastener
Ref: 42250



RD-1 Fastener set
black
Ref: 42650



RD-1 Fastener set
silver
Ref: 42649



RG-1 Fastener set
black
Ref: 42648



RG-1 Fastener set
silver
Ref: 42647



TEKNIK Latch
Ref: 24003

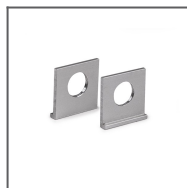

UCHO-ZM Hanger
Ref: 42512



UCHO-ZM black
Hanger
Ref: 42525

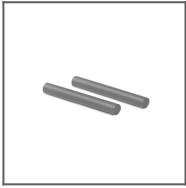

ZM Block
Ref: 42520

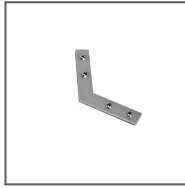

ZM-120
Connector
Ref: 42728

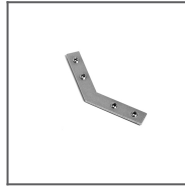

ZM-135
Connector
Ref: 42720

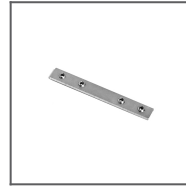

ZM-180
Connector
Ref: 42717



ZM-90 Connector
Ref: 42716

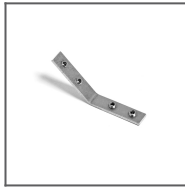

ZM-PION-135
Connector
Ref: 42719

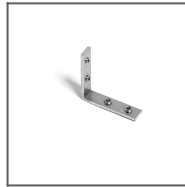

ZM-PION-90
Connector
Ref: 42718

LED TAPES



LED strip 5K-WP-
K-1091-24V
9.1W/m
Ref: 5K-WP-
K-1091-24V