

PRODUCT DESCRIPTION

- Hides the light source - the brightest, contrasting element of the lighting fixture
- Illuminates the interior in an extremely sophisticated and atmospheric manner while maintaining the parameters and functionality of standard lighting fixtures
- Narrow light angle
- The recessed cover minimalize the gleaming effect
- Allows the use of more efficient, transparent covers without compromising the aesthetics of the lighting fixture (LED points remain invisible)
- Allows you to create continuous light arrangements
- An extensive range of fasteners

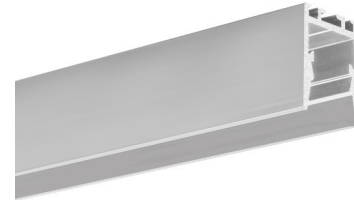

FINISH :

Silver anodized Black anodized

*Custom colors available upon request

Fill empty fields

Product nr.	
Fixture type	
Company	
Job name	
Date	

TECHNICAL SPECIFICATION

Application

- for use in interior architecture
- for creating linear lighting fixtures, continuous light arrangements
- for backlighting components where the light source is to remain hidden

Assembly

- mounted to the surface with appropriate mounting adhesives, mounting springs and screws
- suspended with the UCHO-ZM fastener or the PUSZ system

Additional information

The advantages of the lighting fixture can best be observed with the black finish of the profile walls. We recommend the anodized black satin finish. The fixture minimizes glare without causing discomfort. The source of light is concealed in the PDS-ZMG profile which makes larger interiors with a large number of lighting fixtures more comfortable, as your eyes are not exposed to the brightest part of the fixture.

It can be equipped with transparent or frosted covers We recommend use in the kitchen under cupboards, especially in open kitchenettes; wherever you can see the lighting fixture from a sitting or lying position or from

a child's height. The fixture can be equipped with transparent or frosted covers.

- spece for LED strip: 14.4 mm

PDS-ZMG profile		
Cover	Lighting angle approx	UGR depending on the used LED strip
LIGER	80°	from 12,4 to 16,5
HS - frosted	70°	from 12 to 15,9
HS - transparent	50°	from 2,7 to 7,2

UGR < 19 when looking across to the axis of the lighting fixture

AVAILABLE LENGTHS

Ref. nr.	surface finish	available lengths
C1418K7_1	Black anodized	1000 mm
C1418K7_2	Black anodized	2000 mm
C1418K7_3	Black anodized	3000 mm
C1418ANODA_1	Silver anodized	1000 mm
C1418ANODA_2	Silver anodized	2000 mm
C1418ANODA_3	Silver anodized	3000 mm

TECHNICAL DRAWING

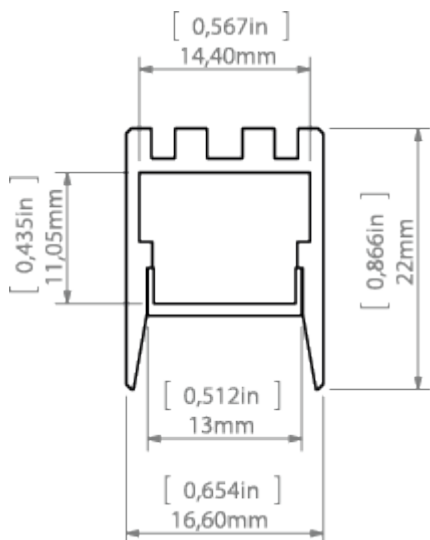

RELATED PRODUCTS

COVERS

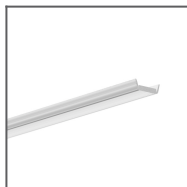

HS clear Cover
Ref: 1370

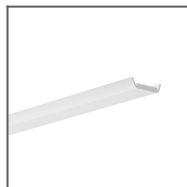

HS frosted Cover
Ref: 1369

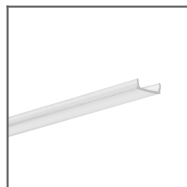

KA clear Cover
Ref: 17036

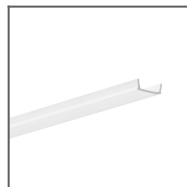

KA frosted Cover
Ref: 17035

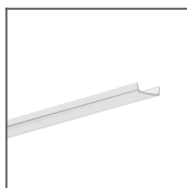

KA-COM clear Cover
Ref: 17122

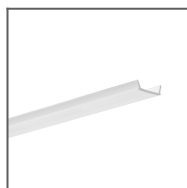

KA-COM frosted Cover
Ref: 17121

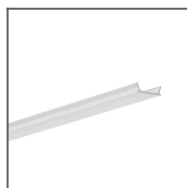

KA-PRO clear Cover
Ref: 17065

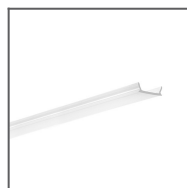

KA-PRO frosted Cover
Ref: 17064

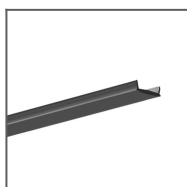

LIGER black Cover
Ref: 17040

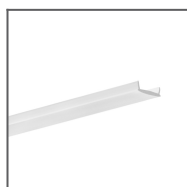

LIGER frosted Cover
Ref: 17037

END CAPS



PDS-G black end cap
Ref: 24320

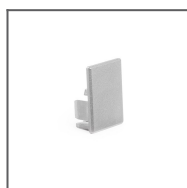

PDS-G grey end cap
Ref: 24330

ACCESSORIES



8,8x1,2 Gland
Ref: 00802



BZP Head
Ref: 42213



BZP-ZO Head
Ref: 42214



BZP-ZZ Head
Ref: 42215



DP-ZO Fastener
Ref: 00649



DP-ZZ Fastener
Ref: 00651



FI-10-ZM-P
Fastener
Ref: 42244



FI-10-ZM-W
Fastener
Ref: 42242

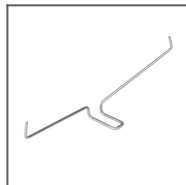

GP Spring
Ref: 00293



Gland
Ref: 42264



M11 Fastener set
Ref: 42609



M12 Fastener set
Ref: 42610



M13 Fastener set
Ref: 42611



M3 Fastener set
Ref: 42303



PUSZ-LIN-ZM
Fastener
Ref: 42256



PUSZ-PRET-ZM
Fastener
Ref: 42250



RD-1 Fastener set
black
Ref: 42650



RD-1 Fastener set
silver
Ref: 42649



RG-1 Fastener set
black
Ref: 42648



RG-1 Fastener set
silver
Ref: 42647

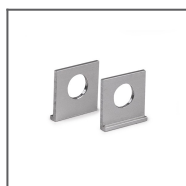

UCHO-ZM Hanger
Ref: 42512

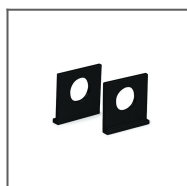

UCHO-ZM black
Hanger
Ref: 42525



W1 Fastener set
Ref: 42602



W2 Fastener set
Ref: 42603



W6 Fastener set
Ref: 42604



W7 Fastener set
Ref: 42605

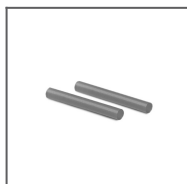

ZM Block
Ref: 42520

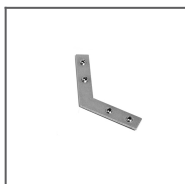

ZM-120
Connector
Ref: 42728



ZM-135
Connector
Ref: 42720

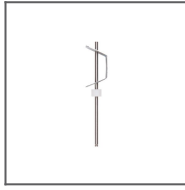

ZM-150 Fastener
Ref: 42118

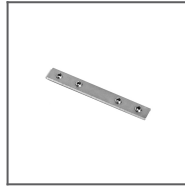

ZM-180
Connector
Ref: 42717

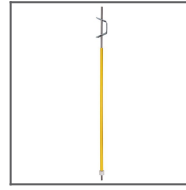

ZM-500 Fastener
Ref: 42119

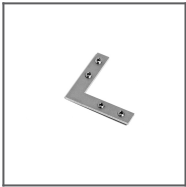

ZM-90 Connector
Ref: 42716

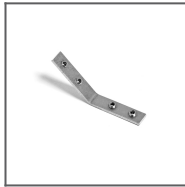

ZM-PION-135
Connector
Ref: 42719

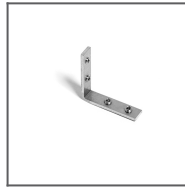

ZM-PION-90
Connector
Ref: 42718