

PRODUCT DESCRIPTION

- Serviceable from the bottom, which allows it to be placed "wall to wall"
- Possibility to build an LED lighting fixture with a low unified glare rating (UGR) below 19 (with the JUN-50 prismatic cover)
- The fixture can accommodate power supplies and control electronics
- Systematic solution for convenient assembly and disassembly
- Upward/downward illumination possible
- Ability to create lighting fixtures with high luminous efficiency
- Luminous efficiency can be increased by 20% by using REFLEX 16-60 reflectors
- Resistance to vibrations and oscillations which increases safety
- Can be combined into singular and sectioned runs
- Can be lacquered (without affecting the color of light)
- Can be used with flexible LED strips rigid LED modules

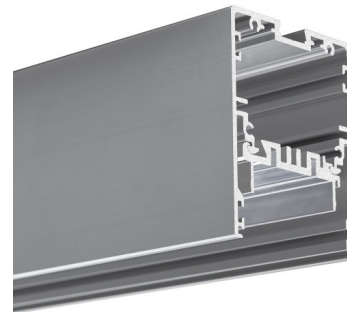

FINISH :

Silver anodized

*Custom colors available upon request

Fill empty fields

Product nr.	
Fixture type	
Company	
Job name	
Date	

TECHNICAL SPECIFICATION

Application

- for the construction of advanced ceiling light fixtures, mounted to the surface or suspended where surface mounting is difficult.

Assembly

- comfortable and reliable assembly
- the possibility of using self-tapping screws

Additional information

- the MOD-50 lighting fixture can be anodized or painted. The MOD-50 lighting fixture can generate a strong downward beam (two LED strips 10 mm wide or a single firm LED module up to 24 mm wide) and an upward backlight beam (one 10 mm LED strip)
- the MOD-50 lighting fixture is designed so that its "core" (extrusion with LED strips, power supply, wires) can be fully prepared in advance (in factory conditions). At the destination of mounting, the ready "core" of MOD-50 can be snapped into the previously mounted housing frame and connected to power

- for each 1m of the lighting fixture, two locking bolts must be used. With lighting fixtures shorter than 1 m, at least 2 bolts must be used

span {font-weight:600;}

The MOD-50 lighting fixture is compatible with the following covers:

- JUN-50 prismatic, material: PMMA, length: 1.5 m, UV resistant , the possibility of obtaining a glare factor UGR ≤ 19
- POL-50 frosted, material: PC, lengths: 1 m, 2m, 3 m, UV resistant

AVAILABLE LENGTHS

Ref. nr.	surface finish	available lengths
18047ANODA_1	Silver anodized	1000 mm
18047ANODA_2	Silver anodized	2000 mm
18047ANODA_3	Silver anodized	3000 mm

TECHNICAL DRAWING

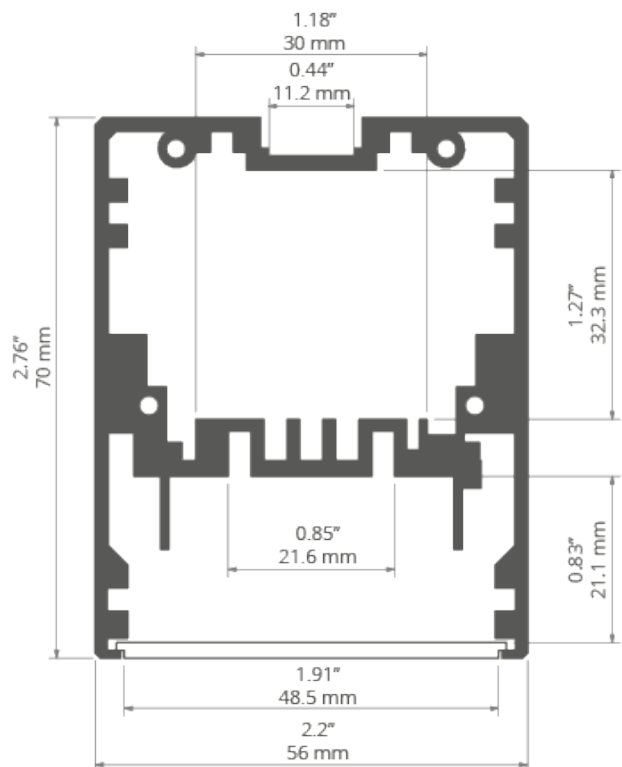

RELATED PRODUCTS

COVERS

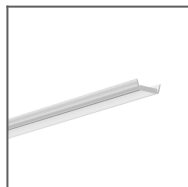

HS clear Cover
Ref: 1370



HS frosted Cover
Ref: 1369

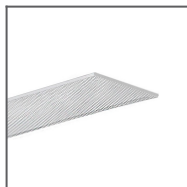

JUN-50 prismatic
Cover
Ref: 17056_1.5

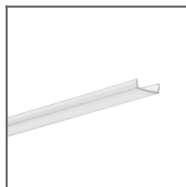

KA clear Cover
Ref: 17036

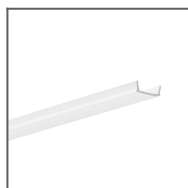

KA frosted Cover
Ref: 17035

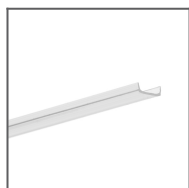

KA-COM clear
Cover
Ref: 17122

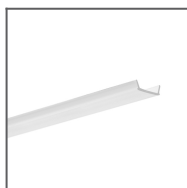

KA-COM frosted
Cover
Ref: 17121

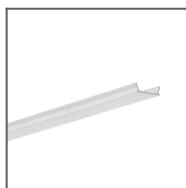

KA-PRO clear
Cover
Ref: 17065

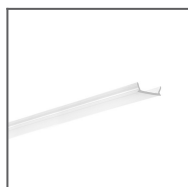

KA-PRO frosted
Cover
Ref: 17064



LIGER frosted
Cover
Ref: 17037

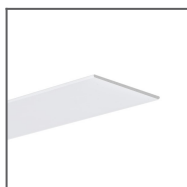

POL-50 frosted
Cover
Ref: 17058

END CAPS



MOD-50 grey End
cap
Ref: 24329

ACCESSORIES



Gland M8X1
Ref: 42265



M4-12 Fastener
Ref: 42246



REFLEX 16-60
Reflector
Ref: 17003



Screw 2.9X6.5
DIN7981F
Ref: 70283