

PRODUCT DESCRIPTION

- Can be easily and quickly attached to and removed from the surface
- Conceals the light source - the brightest, contrasting element of the lighting fixture.
- Narrow light angle
- The recessed cover eliminates the gleaming effect
- Allows the use of more efficient, transparent covers without compromising the aesthetics of the lighting fixture (LED points remain invisible)

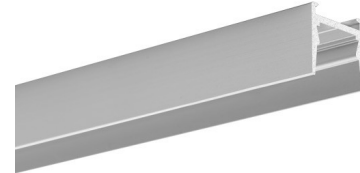

FINISH :

Silver anodized Black anodized

*Custom colors available upon request

Fill empty fields

Product nr.	
Fixture type	
Company	
Job name	
Date	

TECHNICAL SPECIFICATION

Application

- for use in interior architecture and furniture
- for backlighting components where the light source is to remain invisible

Assembly

- mounted to the surface with the "H" bracket

Additional information

- the lighting fixture enables collision-free lighting of individual areas in the apartment and minimizes glare without causing discomfort. The concealed source of light in the MICRO-HG profile makes larger interiors with a large number of lighting fixtures more comfortable, as your eyes are not exposed to the brightest part of the lighting fixture.
- we recommend use in the kitchen under cupboards, especially in open kitchenettes; wherever you can see the lighting fixture from a sitting or lying position or from a child's height
- the fixture can be equipped with transparent or frosted covers
- spece for LED strip: 11.2 mm

MICRO-HG profile

Cover	Lighting angle approx	UGR depending on the used LED strip
LIGER	90°	from 17 to 21,3
HS - frosted	85°	from 16,1 to 20,7
HS - transparent	80°	from 16,7 to 20,2

UGR < 19 when looking across to the axis of the lighting fixture

AVAILABLE LENGTHS

Ref. nr.	surface finish	available lengths
C1419ANODA_1	Silver anodized	1000mm
C1419ANODA_2	Silver anodized	2000mm
C1419ANODA_3	Silver anodized	3000mm
C1419K7_1	Black anodized	1000 mm
C1419K7_2	Black anodized	2000 mm
C1419K7_3	Black anodized	3000 mm

TECHNICAL DRAWING

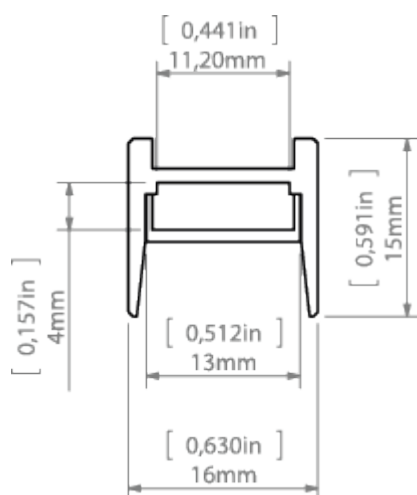

RELATED PRODUCTS

COVERS

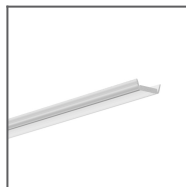

HS clear Cover
Ref: 1370

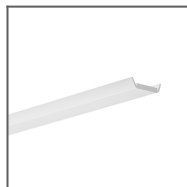

HS frosted Cover
Ref: 1369

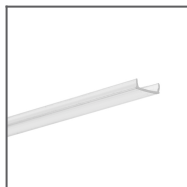

KA clear Cover
Ref: 17036

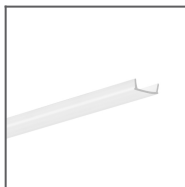

KA frosted Cover
Ref: 17035

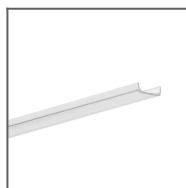

KA-COM clear Cover
Ref: 17122

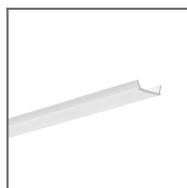

KA-COM frosted Cover
Ref: 17121

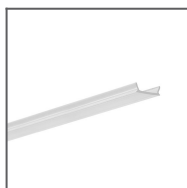

KA-PRO clear Cover
Ref: 17065

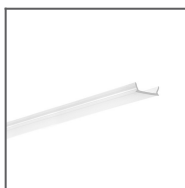

KA-PRO frosted Cover
Ref: 17064

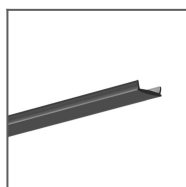

LIGER black Cover
Ref: 17040

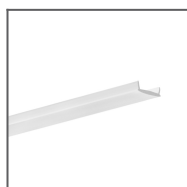

LIGER frosted Cover
Ref: 17037

END CAPS

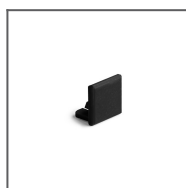

MICRO-G black End cap
Ref: 24331

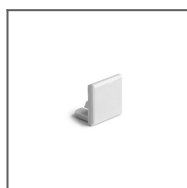

MICRO-G grey End cap
Ref: 24319

ACCESSORIES



8,8x1,2 Gland
Ref: 00802



BZP Head
Ref: 42213



BZP-ZO Head
Ref: 42214



FI-10-H-P Fastener
Ref: 42245



FI-10-H-W
Fastener
Ref: 42243



M11 Fastener set
Ref: 42609



M12 Fastener set
Ref: 42610

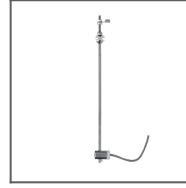

M13 Fastener set
Ref: 42611



M3 Fastener set
Ref: 42303



PDS-H Mounting
bracket
Ref: 24214



PUSZ-LIN-MR
Fastener
Ref: 42258



PUSZ-PRET-MR
Fastener
Ref: 42252



W1 Fastener set
Ref: 42602



W2 Fastener set
Ref: 42603



W6 Fastener set
Ref: 42604



W7 Fastener set
Ref: 42605