

**Parts needed to mount the TETRA-78 extrusion**



Extrusion (A)



Mounting strip (B)



Extrusion end cap (C)



Mounting strip end cap (D)



Mounting strip end cap (D)



Cover (F)



LED strip (G)



Clip (H)

**Tools needed for mounting:**

- drill
- screwdriver
- hand saw
- Allen wrenches (dia. 3 mm, dia. 5 mm)

**NOTE!** All LED strips must be connected to a 12 V or 24 V power supply.

**IMPORTANT:** The manual presents the simplest mounting procedure. More mounting procedures and related accessories can be found at [www.klusdesign.eu](http://www.klusdesign.eu)

**1.** Mount the LED strips (G), insert covers (F), and then insert the end cap (C). Feed the power cable.

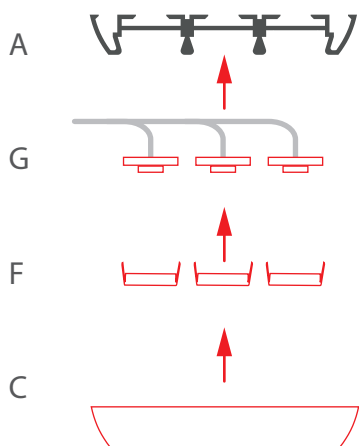

**2.** Drill mounting holes in the surface and mounting strip (B).

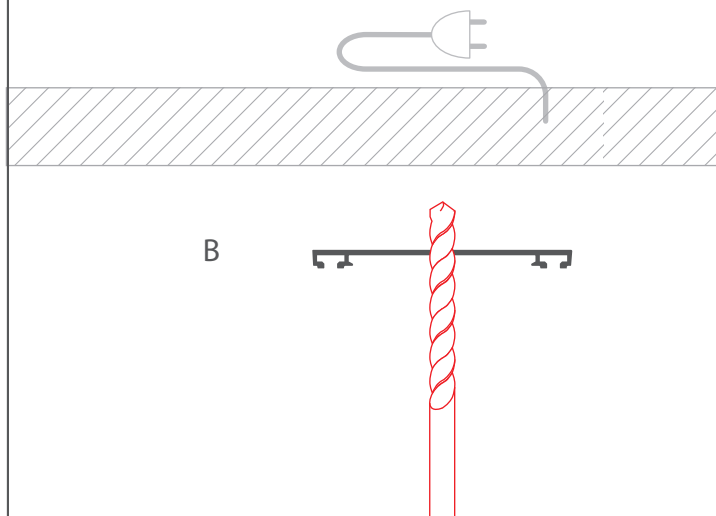

**3.** Attach the mounting strips with screws (B). Insert clips (H) into the mounting strip.

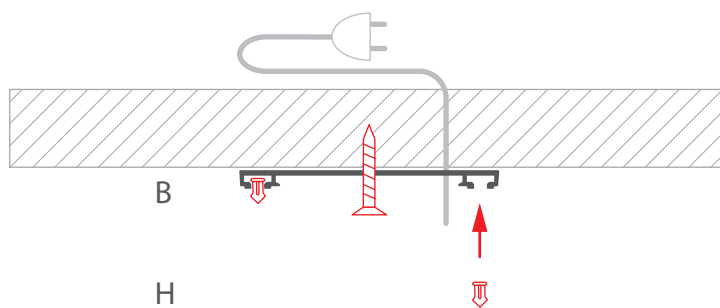

**4.** Connect power and snap the extrusion (A) into the mounting strip (B).

