

**PRODUCT DESCRIPTION**

Standard conductive fastener for light-weight fixtures. The extrusion is inserted into the MOUNTING BRACKET for the 45 - ALU profile. Power is supplied outside the fastener to a power connector. One current pole is powered from one fastener that is equipped with a longitudinal hole for the FI-3 ROD, which acts as a power conductor

Fill empty fields

Product nr.	
Fixture type	
Company	
Job name	
Date	



**TECHNICAL SPECIFICATION**

**TECHNICAL DRAWING**

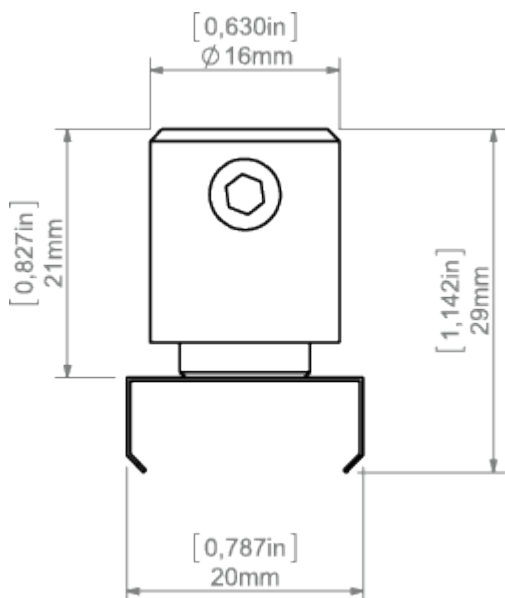

**RELATED PROFILES**

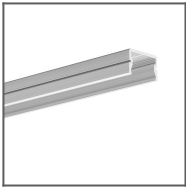

SILER Profile  
Ref: B9325

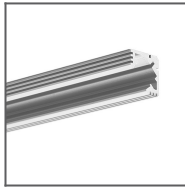

45-ALU Profile  
Ref: B4023

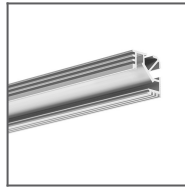

TAN-C5 Profile  
Ref: B5391

**RELATED PRODUCTS**

**ACCESSORIES**

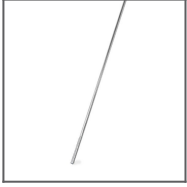

100 PUSZ brass  
chrome Rod 1 m  
Ref: 42518

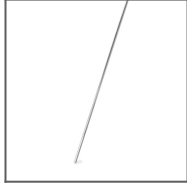

Brass chrome FI-3  
Rod 1m  
Ref: 42501

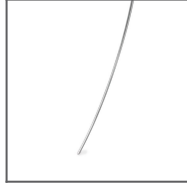

Steel FI-3 Rod 53  
cm  
Ref: 1528

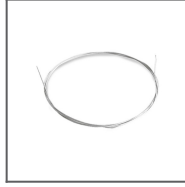

Steel wire FI-1 1m  
Ref: 1397