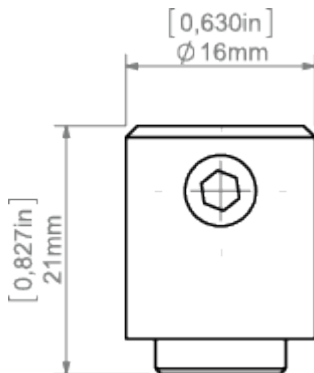

PRODUCT DESCRIPTION

Standard fastener for light-weight fixtures. It is inserted into the extrusion through a pre-drilled hole. The fastener is equipped with a longitudinal hole for the FI-3 ROD

Fill empty fields

Product nr.	
Fixture type	
Company	
Job name	
Date	

**TECHNICAL SPECIFICATION****TECHNICAL DRAWING**

RELATED PROFILES

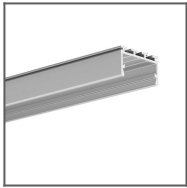

GIZA-LL profile
Ref: C0758

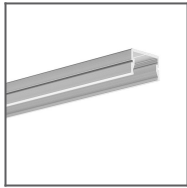

SILER Profile
Ref: B9325

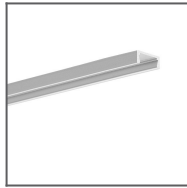

MICRO-ALU Profile
Ref: B1888

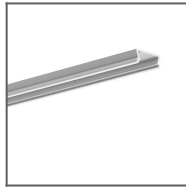

TAMI Profile
Ref: B5390

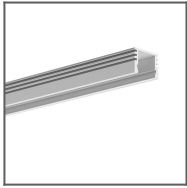

PDS-4-ALU Profile
Ref: B1718



REGULOR Profile
Ref: B468+43

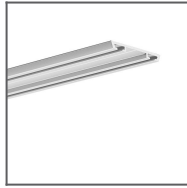

TEST-36 Profile
Ref: B6639

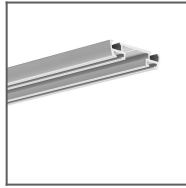

TEST-74 Profile
Ref: W4507



TETRA-43 Profile
Ref: W4476



TETRA-78 Profile
Ref: W4508

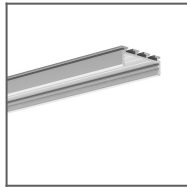

GIZA Profile
Ref: B5556

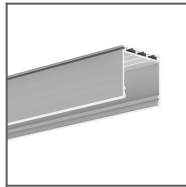

LIPOD Profile
Ref: B5554



PDS-4-PLUS
Profile
Ref: C1263

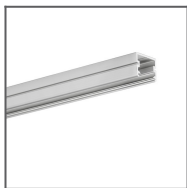

TAPO Profile
Ref: C1919

RELATED PRODUCTS

ACCESSORIES



100 PUSZ brass
chrome Rod 1 m
Ref: 42518



Brass chrome FI-3
Rod 1m
Ref: 42501

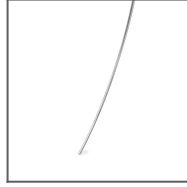

Steel FI-3 Rod 53
cm
Ref: 1528

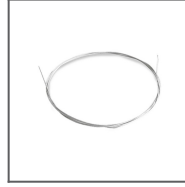

Steel wire FI-1 1m
Ref: 1397